

RELAY

DIGITAL LINE MONITORING RELAY

Standards
IEC 61010-1-2010 | IEC 61326-1



Digital Line Monitoring Relay

Description

The Digital Line Monitoring Relay is an advanced solution designed to provide comprehensive protection and precise monitoring of electrical systems.

Ideal for a wide range of industrial and commercial applications, this relay ensures the safety and efficiency of electrical operations by quickly detecting and responding to various abnormal conditions.

Equipped with True RMS measurement technology and advanced fault storage features, this device is essential for maintaining the integrity of sensitive and critical equipment.

Dimensions

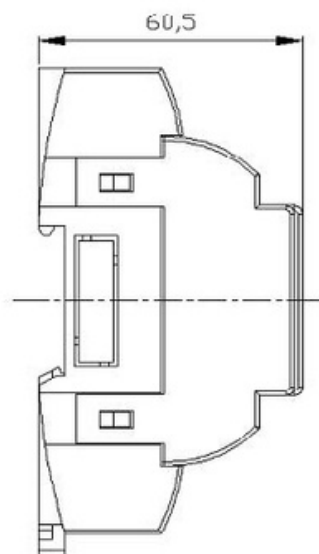
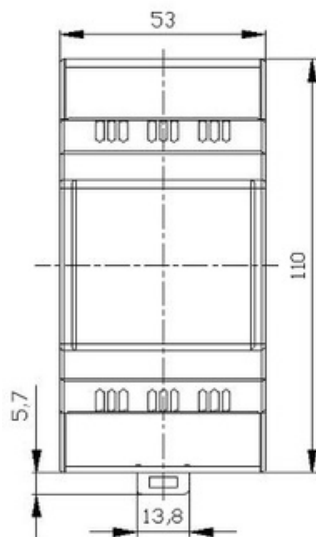

Applications

- Overvoltage
 - Undervoltage
 - Generator unit startup
 - Power grid protection unit operation
 - Hybrid source switching
 - Computer power supply protection
 - Precise equipment control
 - Gensets - for monitoring the correct operation of the voltage regulator and excitation system
 - Motors - Some electric motors are voltage-sensitive and can overheat and burn out when operated at low voltage
 - UPS systems - When the main source falls outside the acceptable voltage range, the relay can initiate switching to an alternative or backup source
 - Motors - Single-phase failures
 - Incorrect connection sequence
-

Digital Line Monitoring Relay

Product Features:

- Overvoltage protection
 - Undervoltage protection
 - Phase failure protection
 - Phase imbalance protection
 - Incorrect phase sequence protection
 - Overfrequency protection
 - Underfrequency protection
 - Ultra-bright 7-segment LED display with 4 digits
 - DPM trip relay with class 0.5
 - True RMS measurements
 - The instrument measures distorted waveforms up to the 15th harmonic
 - LED indications
 - LED indication for the status of relays 1 and 2
 - Trip indications are displayed on the 4-digit display
 - Two-color LED for phase indication: green for normal condition and red for fault condition
 - Three-phase 3W (3 wires) or 4W (4 wires) selectable by the user
 - The user can locally program the grid connection as 1P2W / 3P4W / 3P3W using the front panel keys.
 - User-selectable system phase sequence
 - The user can program the system phase sequence as 123 or 321
 - Parametrizable setpoint for:
 - Overvoltage.
 - Undervoltage.
 - Phase failure.
 - Phase imbalance.
 - Overfrequency.
 - Underfrequency.
 - Adjustable trip time delay for:
 - Overvoltage
 - Undervoltage
 - Phase failure
 - Phase imbalance
 - Overfrequency
 - Underfrequency
 - Storage of previous faults: The instrument stores the last 15 occurred faults
 - **AND** function
 - The user can use the **AND** function to set the trip on any two-fault conditions..
 - Configuration via PRKAB based USB
 - The user can configure the meter using USB-based PRKAB.
 - Trip or Buzzer Mode
 - The relay can be used for system protection or simply to control the buzzer.
 - Trip mode is for protection purposes, and Buzz mode is for alarm control.
 - Automatic/Manual reset:
 - In automatic mode, the instrument resets its protection functions automatically. If set to manual mode, protection functions must be manually reset via the button on the display in case of trip.
 - User-selectable Primary of PT:
 - The primary of the potential transformer can be set locally from 100 V F-F to 1200 kV F-F for voltage trip relay.
 - Local Selection of Auto Scroll/Fixed Screen:
 - The user can configure the display in either auto-scrolling mode or fixed screen mode using the front panel keys.
 - Compliance with International safety standards:
 - Compliance with the international safety standard IEC 61010-1-2010.
 - User-selectable Secondary of PT:
 - The nominal input voltage can be set locally from 100 to 600 V F-F using the front panel keys.
 - EMC Compatibility:
 - Compliance with the International standard IEC 61326-1.
-

Digital Line Monitoring Relay

Operational Elements:

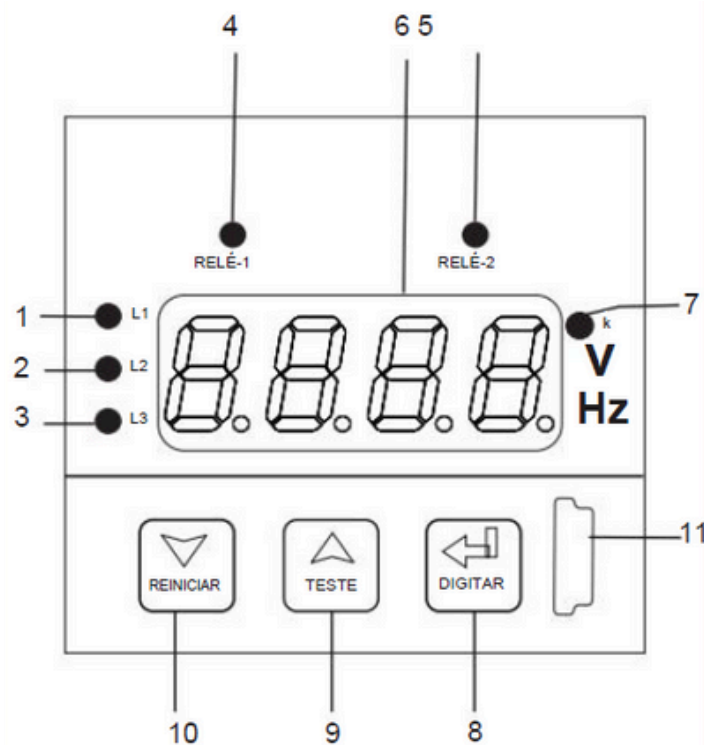

1 - LED L1: Indicates the state of V1 (in 3P4W) and V1-2 in 3P3W. It lights up in green when the input voltage is healthy, red in fault condition, blinking red when waiting for trip, and blinking green when waiting for reset.

2 - LED L2: Indicates the status of V2 (in 3P4W) and V2-3 in 3P3W. It lights up in green when the input voltage is healthy, red in fault condition, blinking red when waiting for trip, and blinking green when waiting for reset.

3 - LED L3: Indicates the status of V3 (in 3P4W) and V3-1 in 3P3W. It lights up in green when the input voltage is healthy, red in fault condition, blinking red when waiting for trip, and blinking green when waiting for reset.

4/5 - Relay-1 and Relay-2 status LEDs: Indicates the status of relay-1 and relay-2 respectively. They light up in green for a healthy relay condition and red for a tripped relay condition.

6 - Ultra-bright 7-segment LED display with 4 digits.

7 - LED K: Switches the scale to KV.

8 - Enter key: Confirms parameter configuration changes. When on the measurement screen, holding it for 3 seconds enters the configuration menu.

9 - Test key: Increases the configuration value, moves upward in the menu, or changes parameters. It is also used to test relay operation. Holding the test key continuously changes the relay position, and releasing it resets the relay position (only under normal conditions).

10 - Reset key: Decreases the configuration value, moves downward in the menu, or changes parameters. It is also used to reset the relay when manual reset mode is selected.

11 - USB port for configuration.

Digital Line Monitoring Relay

Parameter settings

Phase failure trip setting	20 - 85%
Voltage imbalance trip setting	2 - 20%
Overvoltage trip setting	101 - 125%
Undervoltage trip setting	70 - 99%
Maximum frequency trip setting	101 - 110%
Minimum frequency trip setting	90 - 99%
- Differential/hysteresis setting	1 - 15%*
Configurable nominal frequency	50/60 Hz
Individual faults can be deactivated as per system requirements	Yes (phase failure cannot be deactivated)
Reset option	Automatic/Manual
Relay control mode	De-energize/energize
Reset delay	0,2 - 30s
Programmable trip delay for overvoltage, undervoltage, overfrequency, underfrequency, phase failure, phase imbalance	0 - 30s
Primary voltage PT (V Line-Line)	100 - 1200 kV L-L
Startup time	0,5 - 30s

NOTE: Regenerated voltage can occur on the open phase due to a blown fuse for some loads. In this case, set the Phase Failure trip point (20 - 85%) according to requirements considering the possibility of higher regenerated voltage.

The range for Differential setting for Voltage Imbalance is limited according to your trip point configuration.

Digital Line Monitoring Relay

Method of hysteresis calculation:

Example 1:

For "OV" (Overvoltage):

Secondary of PT = 100 V

Trip point = 105% of Secondary of PT = 105 V

Hysteresis = 2% of Secondary of PT = 2 V

Relay reset point = Trip point - Hysteresis
 = 105 - 2
 = 103 V

Example 2:

For "Ph.un" (Phase imbalance):

Secondary of PT = 100 V

Trip point = 10% of Secondary of PT = 10 V

Hysteresis = 2% of Secondary of PT = 2 V

Relay reset point = Trip point - Hysteresis
 = 10 - 2
 = 8 V

Electrical connections

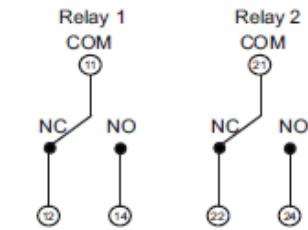
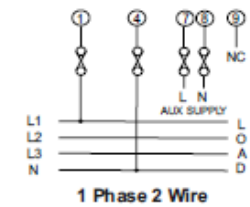
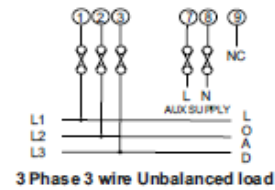
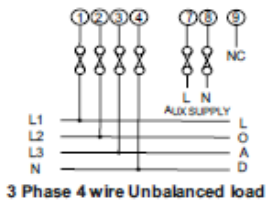

Note-Relay Contacts are shown in power off condition

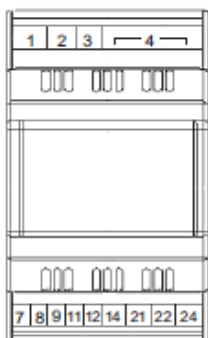

ANSI Protection Functions

Code	Function
27	Under-voltage relay
47	Phase sequence voltage or phase imbalance relay
59	Over-voltage relay
81	Over/under-frequency relay

Overvoltage (OV) and Undervoltage (UV)

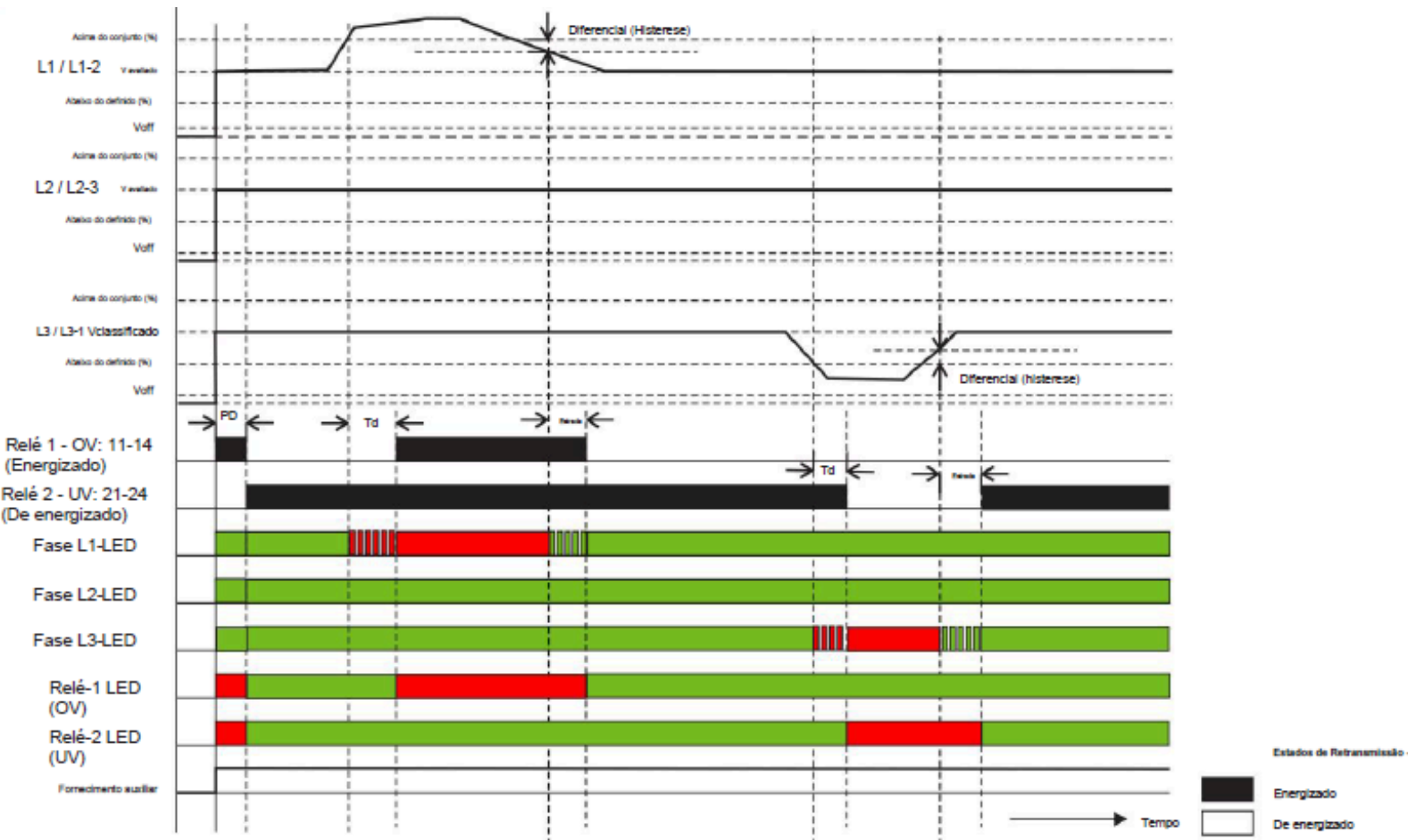

Phase failure (Ph.F) and phase imbalance (Ph.un)

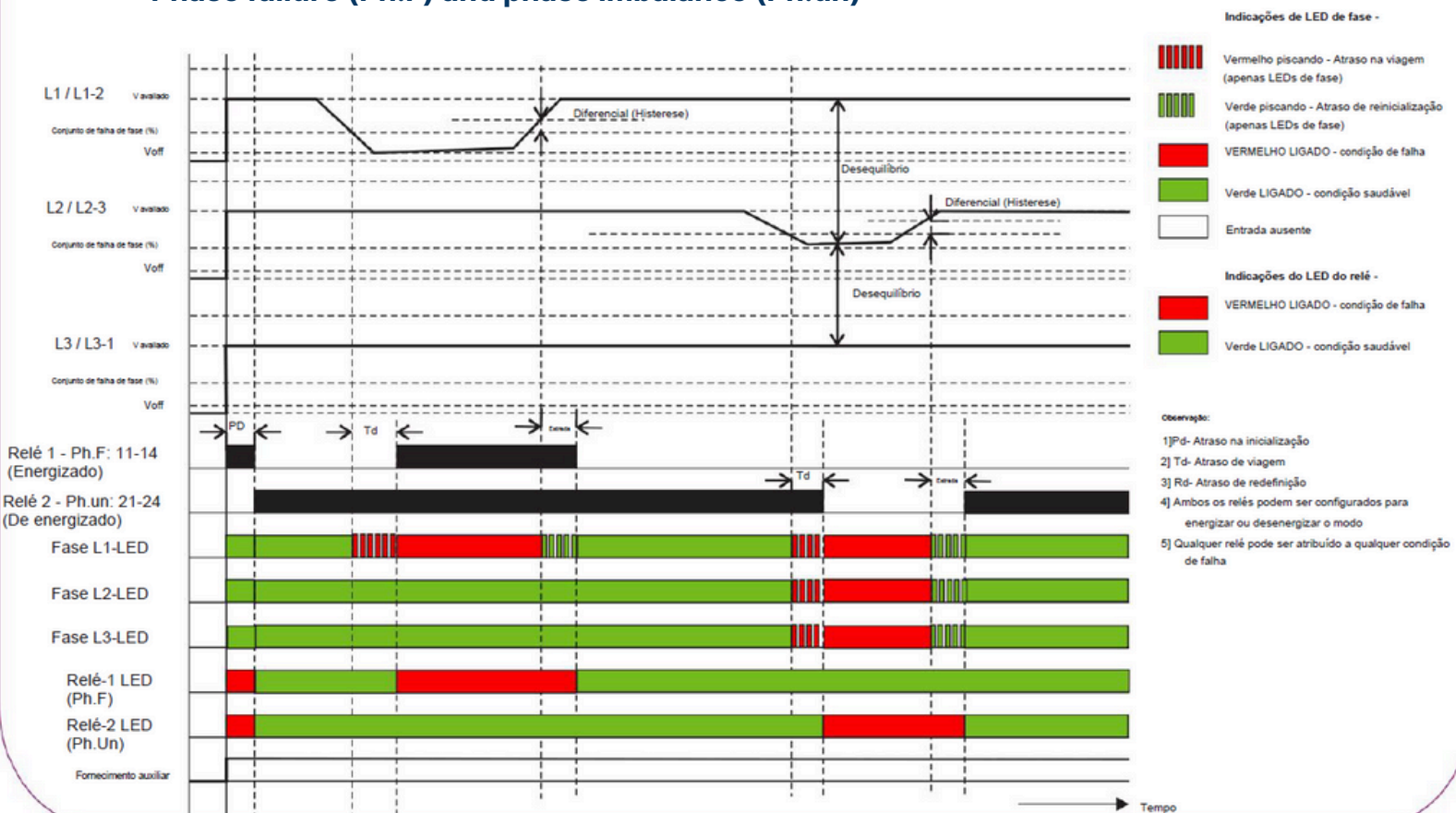

Overfrequency (OF) and Underfrequency (UF)

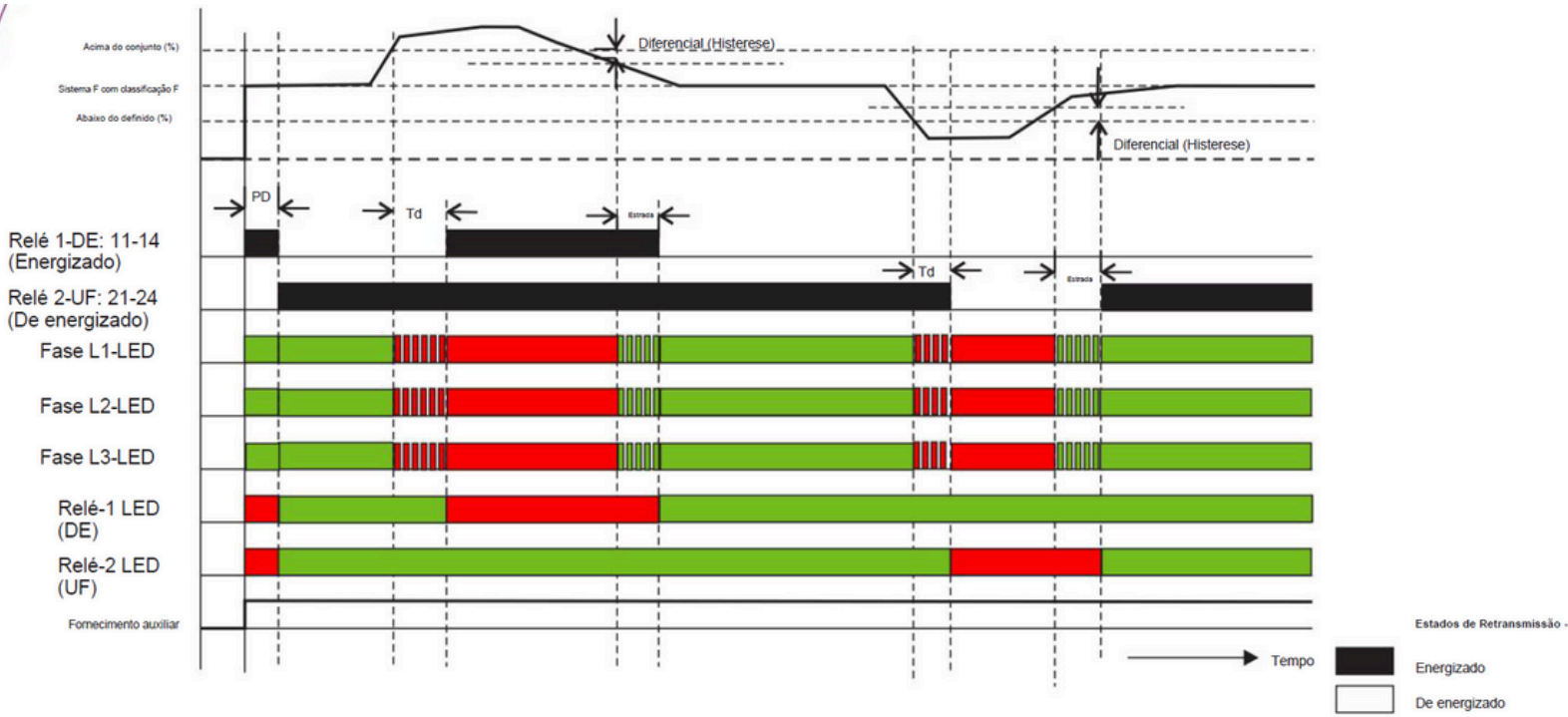

Phase sequence (Ph.r)

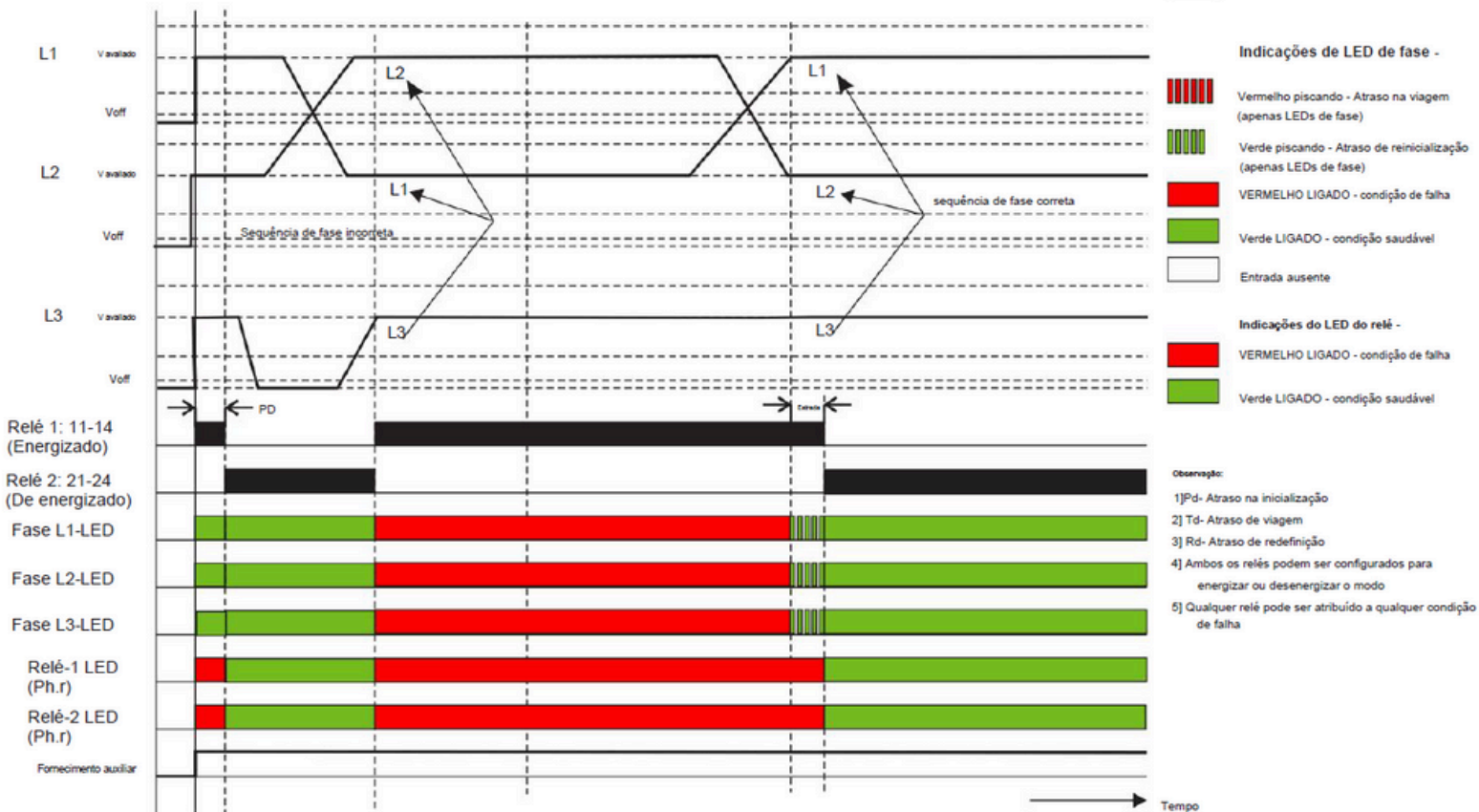

Technical Specifications

Input voltage:

Nominal input voltage (AC RMS)	600 V Line-Line (346.42 V Line-Neutral)
Maximum continuous input voltage	127% of Secondary of PT
Primary of PT	Locally programmable from 100 V Line-Line to 600 V Line-Line
Secondary of PT	Locally programmable from 100 V Line-Line to 1200 kV Line-Line
Nominal frequency	50/60 Hz (locally programmable)
Input voltage burden	< 0,6 VA

Auxiliary supply:

External Upper Auxiliary	60 V – 300 V AC/DC
Nominal value of Upper Auxiliary	230 V AC/DC 50/60 Hz for AC Aux
External Lower Auxiliary	20 V – 60 V DC / 20 V – 40 V AC
Nominal value of Lower Auxiliary	48 VDC / 24 VAC 50/60 Hz for AC Aux
Auxiliary supply frequency	Range from 45 to 66 Hz
Auxiliary supply burden	< 4 VA

Operational measurement ranges

Voltage range	20% to 125% of Secondary of PT
Frequency	40 to 70 Hz

Reference condition for accuracy

23 °C ± 2 °C
Sinusoidal waveform (distortion factor 0.005)
50 or 60Hz ± 2%
Nominal value ± 1%
Nominal value ± 1%

Technical Specifications

Accuracy:

Voltage	$\pm 0,5\%$ of nominal value
Frequency	$\pm 0,2$ Hz
Startup, trip, reset delays	± 140 ms or $\pm 5\%$ of the defined delay, whichever is greater

Influence of variations

Temperature coefficient	0,025% / °C for voltage
-------------------------	-------------------------

Applicable standards

EMC	IEC 61326-1:2012, Table 2
Immunity Low level	CEI 61000-4-3. 10 V/m min – Level 3 industrial
Safety	CEI 61010-1-2010 (Continuous use)
IP rating for water and dust	CEI60529
Pollution degree	2
Installation category	300 V CAT III / 600 V CAT II
High voltage test	2,2 kV AC, 50 Hz for 1 minute

Features and conditions

Transient overvoltage withstand capability	2 x nominal value for 1 second, repeated 10 times within 10 seconds
Operating temperature	-10 to +55 °C
Storage temperature	-25 to +70 °C
Relative humidity	up to 90% non-condensing
Vibration	10 to 55 Hz, amplitude of 0,15 mm
Protection degree	IP20 (front panel only)
Weight	300g Aprox.

Technical Specifications

Mechanical endurance	10000000 operations
Electrical endurance	NO: 30000 operations
	NC: 10000 operations for relay 1CO / 1CO+1CO
	100000 operations for relay 2CO

Relay contacts

Types of outputs	1CO, 2CO, 1CO+1CO
Contact rating (resistive load)	5 A / 250 VAC / 30 VDC

We provide solutions for improvement of electrical energy generation, transmission and distribution efficiency, quality and reliability. With a highly specialized and experienced team in research, development and innovation, HVEX develops tailor-made solutions for Brazilian and foreign markets. Wide range of products with solutions focused on signal transduction, measurement, monitoring and protection.



Boosting the Innovation



☎ 35 3622-2699

✉ contato@hvex.com.br

🌐 www.hvex.com.br

📍 R. Ismael Pinto de Noronha, 86,
Nossa Sra. de Fatima, Itajubá-MG